

General Description

The Micrel MIC2203 is a high efficiency 1MHz PWM synchronous buck switching regulator. The MIC2203 features low noise constant frequency PWM operation with a low dynamic supply current of <math><1\text{mA}</math>. The low noise and efficient operation both make the MIC2203 well suited for sensitive RF, and audio power applications.

The MIC2203 operates from 2.3V to 5.5V input and can supply over 300mA of output current with output voltages down to 0.5V. Additionally, the MIC2203 can be synchronized to an external clock, or multiple MIC2203s can easily be daisy-chained with the SYNCLOCK feature.

The MIC2203 has a high loop bandwidth with corresponding ultra fast transient response times. This reduces the output capacitor size, and is very useful when powering applications that require fast dynamic response such as CPU cores and RF circuitry in high performance cellular phones and PDAs.

The MIC2203 is available in 10-pin MSOP and 3mm x 3mm MLF[™]-10L package options with an operating junction temperature range from -40°C to 125°C .

Features

- Input voltage range: 2.3V to 5.5V
- Output voltage adjustable down to 0.5V
- 300mA output current
- Constant 1MHz PWM switching frequency
- $> 95\%$ efficiency
- $< 1\text{mA}$ switching supply current
- $< 350\mu\text{A}$ static quiescent current
- $< 1\mu\text{A}$ shutdown current
- All-ceramic capacitors
- Easily synchronized to external clock
- SYNCLOCK feature to daisy chain multiple devices
- Thermal shutdown and current limit protection
- 10 pin MSOP, and 3mm x 3mm MLF-10L package options
- -40°C to $+125^{\circ}\text{C}$ junction temperature range

Applications

- 802.11 WLAN modules
- MD players
- MP3 players

Typical Application

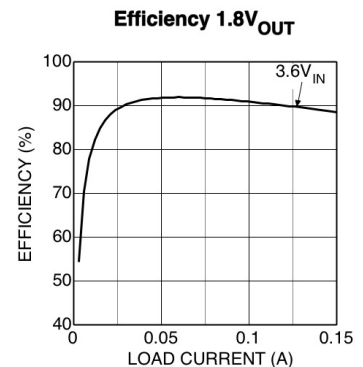
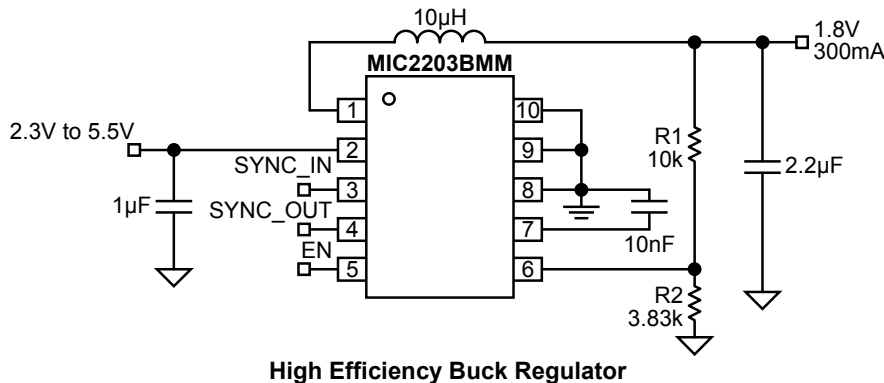

Ordering Information

Part Number		Output Voltage	Junction Temperature Range	Package
Standard	Pb-Free			
MIC2203BMM	MIC2203YMM	Adjustable	-40°C to +125°C	MSOP-10L
MIC2203BML	MIC2203YML	Adjustable	-40°C to +125°C	3mm x 3mm MLF-10L

Pin Configuration

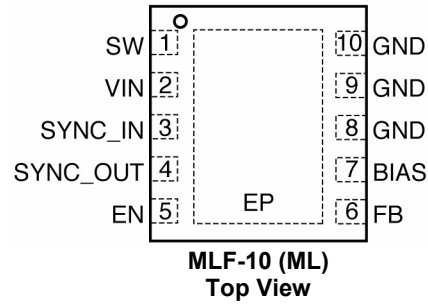
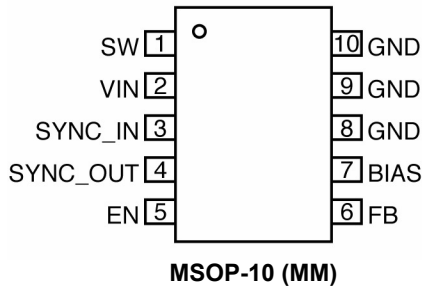

Pin Description

Pin Number	Pin Name	Pin Function
1	SW	Switch (Output): Internal power MOSFET output switches.
2	VIN	Supply Voltage (Input): Requires a bypass capacitor to GND.
3	SYNC_IN	SYNC_IN for the MIC2203, Sync the main switching frequency to a external clock. Should be tied to ground when not in use.
4	SYNC_OUT	SYNC_OUT a 50ns wide sync pulse to feed into SYNC_IN on MIC2203. Can be left open or tied to ground when not used.
5	EN	A low level EN will power down the device, reducing the quiescent current to under 1µA.
6	FB	Input to the error amplifier, connect to the external resistor divider network to set the output voltage.
7	BIAS	Internal circuit bias supply, nominally 2.3V. Must be de-coupled to signal ground and can have a minimum of external DC loading.
8,9,10	GND	Ground
EP	GND	Exposed backside pad, connect to Ground (MLF option only)

Absolute Maximum Ratings⁽¹⁾

Supply Voltage (V_{IN})	6V
Output Switch Voltage (V_{SW})	6V
Logic Input Voltage (V_{EN}, V_{SYNC_IN})	V_{IN} to $-3V$
Power Dissipation	Note 5
Storage Temperature (T_s)	$-65^{\circ}C$ to $+150^{\circ}C$
ESD Rating ⁽³⁾	2kV

Operating Ratings⁽²⁾

Supply Voltage (V_{IN})	2.3V to 5.5V
Junction Temperature Range	$-40^{\circ}C$ to $+125^{\circ}C$
Package Thermal Resistance	
MSOP-10L (θ_{JA})	115 $^{\circ}C/W$
3mmX3mm MLF-10L (θ_{JA})	60 $^{\circ}C/W$

Electrical Characteristics⁽⁴⁾

$T_A = 25^{\circ}C$ with $V_{IN} = V_{EN} = 3.5V$, unless otherwise specified. **Bold** values indicate $-40^{\circ}C < T_J < +125^{\circ}C$

Parameter	Condition	Min	Typ	Max	Units
Supply Voltage Range		2.3		5.5	V
Quiescent Current	$V_{FB} = 0.6V$ (not switching)		320	450	μA
	$EN = 0V$ (shutdown)		0.01	1	μA
No Load Supply Current	(switching)		870		μA
MIC2203 [Adjustable] Feedback Voltage		0.4875	0.5	0.5125	V
Output Voltage Line Regulation	$V_{OUT} < 2V; V_{IN} = 2.3V$ to $5.5V, I_{LOAD} = 50mA$		0.13	0.5	%
Output Voltage Load Regulation	$0mA < I_{LOAD} < 300mA$		0.2	0.5	%
Bias Regulator Output Voltage		2.2	2.32	2.6	V
Maximum Duty Cycle	$V_{FB} \leq 0.4V$	100			%
Current Limit	$V_{FB} = 0.4V$	0.375	0.6	1.5	A
Switch ON-Resistance	$I_{SW} = 300mA, V_{FB} = 0.4V$		1.5	2.2	Ω
	$I_{SW} = -300mA, V_{FB} = 0.6V$		1	1.6	
Enable Input Current			0.01	2	μA
Sync Frequency Range		0.8		1.25	MHz
SYNC_IN Threshold		0.7	1	1.7	V
Sync Minimum Pulse Width			10		ns
SYNC_IN Input Current				1	μA
Oscillator Frequency		0.8	1	1.2	MHz
Enable Threshold		0.5	0.7	1.3	V
Enable Hysteresis			20		mV
Over Temperature Shutdown	Hysteresis		160		$^{\circ}C$
			20		

Notes:

- Exceeding the absolute maximum rating may damage the device.
- The device is not guaranteed to function outside its operating rating.
- Devices are ESD sensitive. Handling precautions recommended. Human body model, 1.5k in series with 100pF.
- Specification for packaged product only.
- Absolute maximum power dissipation is limited by maximum junction temperature where $P_{D(MAX)} = (T_{J(MAX)} - T_A) \div \theta_{JA}$.

Typical Characteristics

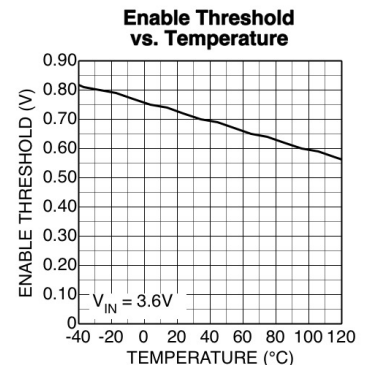
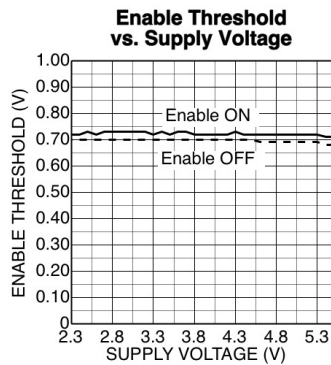
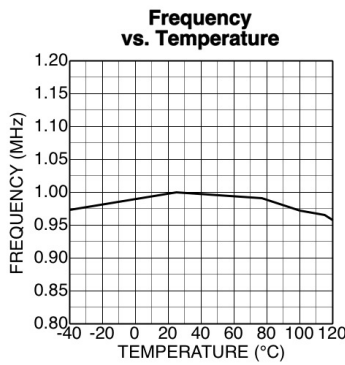
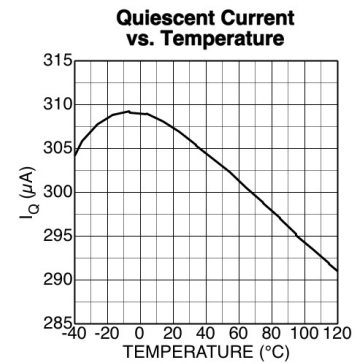
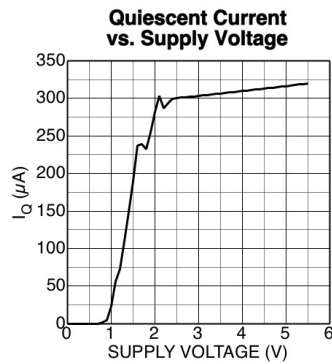
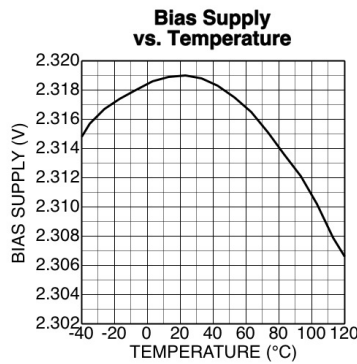
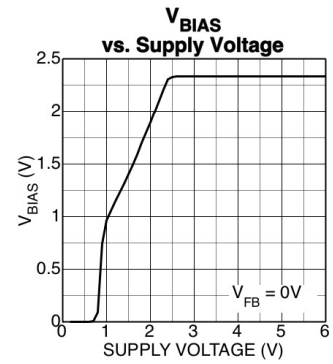
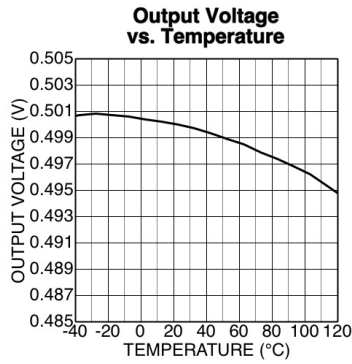
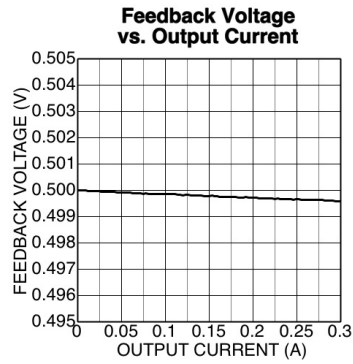

Functional Diagram

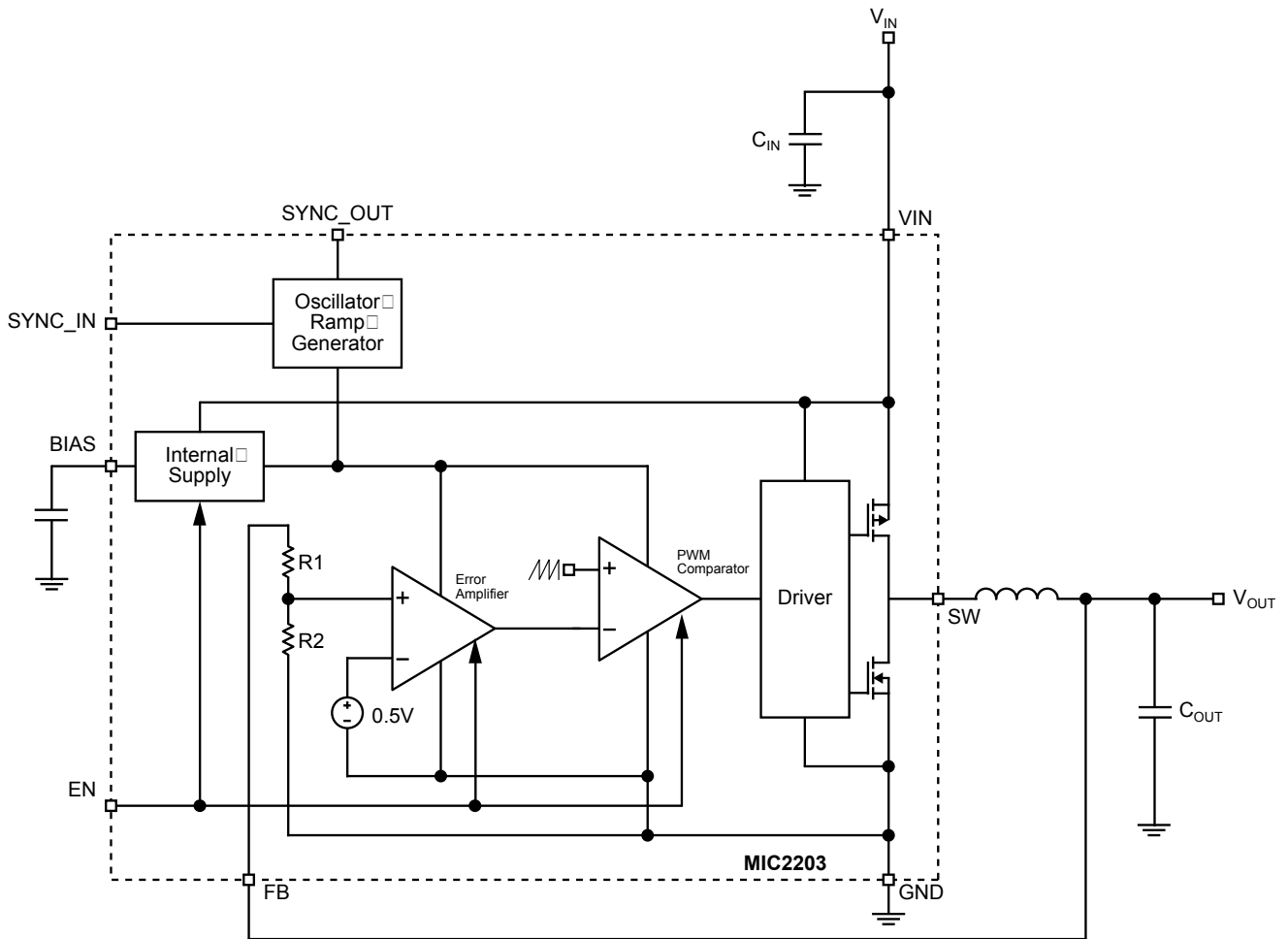

Figure 1. MIC2203 Block Diagram

Functional Description

V_{IN}

V_{IN} provides power to the output and to the internal bias supply. The supply voltage range is from 2.3V to 5.5V. A minimum 1 μ F ceramic capacitor is recommended for bypassing the input supply.

Enable

The enable pin provides a logic level control of the output. In the off state, supply current of the device is greatly reduced (typically <1 μ A). Also, in the off state, the output drive is placed in a “tri-stated” condition, where both the high side P-Channel MOSFET and the low-side N-Channel are in an off or non-conducting state. Do not drive the enable pin above the supply voltage.

SYNC_IN

SYNC_IN pin enables the ability to change the fundamental switching frequency. The SYNC_IN frequency has a minimum frequency of 800KHz and a maximum sync frequency of 1.2MHz. Careful attention should be paid to not driving the SYNC_IN pin greater than the supply voltage. Although this will not damage the device, it can cause improper operation.

SYNC_OUT

SYNC_OUT is an open collector output that provides a signal equal to the internal oscillator frequency. This creates the ability for multiple MIC2203s to be connected together in a master-slave configuration for frequency matching of the converters. A typical 10k Ω resistor is recommended for the pull-up resistor.

Bias

The bias supply is an internal 2.3V linear regulator that supplies the internal biasing voltage to the MIC2203. A 10nF ceramic capacitor is required on this pin for bypassing. Do not use the bias pin as a supply. The bias pin was designed to supply internal power only.

Feedback

The feedback pin provides the control path to control the output. A resistor divider connecting the feedback to the output is used to adjust the desired output voltage. Refer to the feedback section in the “Applications Information” for more detail.

Application Information

Input Capacitor

A minimum 1 μ F ceramic capacitor is recommended on the V_{IN} pin for bypassing. X5R or X7R dielectrics are recommended for the input capacitor. Y5V dielectrics, aside from losing most of their capacitance over temperature, also become resistive at high frequencies. This reduces their ability to filter out high frequency noise.

Output Capacitor

The MIC2203 was designed specifically for the use of a 2.2 μ F ceramic output capacitor. Since the MIC2203 is voltage mode regulator, the control loop relies on the inductor and output capacitor for compensation. For this reason, do not use excessively large output capacitors. The output capacitor requires either an X7R or X5R dielectric. Y5V and Z5U dielectric capacitors, aside from the undesirable effect of their wide variation in capacitance over temperature, become resistive at high frequencies. Using Y5V or Z5U capacitors will cause instability in the MIC2203.

Total output capacitance should not exceed 3 μ F.

Inductor Selection

Inductor selection will be determined by the following (not necessarily in the order of importance):

- Inductance
- Rated current value
- Size requirements
- DC resistance (DCR)

The MIC2203 is designed for use with a 10 μ H inductor.

Maximum current ratings of the inductor are generally given in two methods: permissible DC current and saturation current. Permissible DC current can be rated either for a 40°C temperature rise or a 10% loss in inductance. Ensure the inductor selected can handle the maximum operating current. When saturation current is specified, make sure that there is enough margin that the peak current will not saturate the inductor.

The size requirements refer to the area and height requirements that are necessary to fit a particular design. Please refer to the inductor dimensions on their datasheet.

DC resistance is also important. While DCR is inversely proportional to size, DCR can represent a significant efficiency loss. Refer to the "Efficiency Considerations" below for a more detailed description.

Bias Capacitor

A small 10nF ceramic capacitor is required to bypass the bias pin. The use of low ESR ceramics provides improved filtering for the bias supply.

Efficiency Considerations

Efficiency is defined as the amount of useful output power, divided by the amount of power consumed.

$$\text{Efficiency}\% = \left(\frac{V_{\text{OUT}} \times I_{\text{OUT}}}{V_{\text{IN}} \times I_{\text{IN}}} \right) \times 100$$

Maintaining high efficiency serves two purposes. It reduces power dissipation in the power supply, reducing the need for heat sinks and thermal design considerations, and it reduces consumption of current for battery powered applications. Reduced current drawn from a battery increases the device's operating time, which is critical in hand held devices.

There are two loss terms in switching converters: DC losses and switching losses. DC losses are simply the power dissipation of $I^2 R$. Power is dissipated in the high side switch during the on cycle. Power loss is equal to the high side MOSFET $R_{\text{DS(ON)}}$ multiplied by the (Switch Current)². During the off cycle, the low side N-Channel MOSFET conducts, also dissipating power. Device operating current also reduces efficiency. The product of the quiescent (operating) current and the supply voltage is another DC loss. The current required to drive the gates on and off at a constant 1MHz frequency and the switching transitions make up the switching losses.

Figure 2 shows an efficiency curve. The non-shaded portion, from 0mA to 100mA, efficiency losses are dominated by quiescent current losses, gate drive and transition losses. In this case, lower supply voltages yield greater efficiency in that they require less current to drive the MOSFETs and have reduced input power consumption.

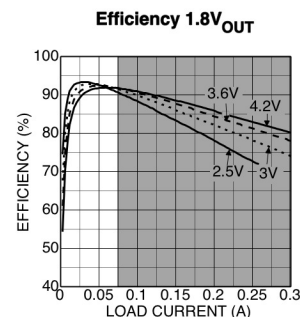

Figure 2. Efficiency Curve

The shaded region, 100mA to 300mA, efficiency loss is dominated by MOSFET $R_{\text{DS(ON)}}$ and inductor DC losses. Higher input supply voltages will increase

the Gate-to-Source threshold on the internal MOSFETs, reducing the internal $R_{DS(ON)}$. This improves efficiency by reducing DC losses in the device. All but the inductor losses are inherent to the device. In which case, inductor selection becomes increasingly critical in efficiency calculations. As the inductors are reduced in size, the DC resistance (DCR) can become quite significant. The DCR losses can be calculated as follows:

$$P_L = I_{OUT}^2 \times DCR$$

From that, the loss in efficiency due to inductor resistance can be calculated as follows:

$$\text{Efficiency Loss} = \left[-1 \left(\frac{V_{OUT} \times I_{OUT}}{V_{OUT} \times I_{OUT} \times P_L} \right) \right] \times 100$$

Efficiency loss, due to DCR, is minimal at light loads and gains significance as the load is increased. Inductor selection becomes a trade-off between efficiency and size in this case.

Compensation

The MIC2203 is an internally compensated, voltage mode buck regulator. Voltage mode is achieved by creating an internal 1MHz ramp signal and using the output of the error amplifier to pulse width modulate the switch node, maintaining output voltage regulation. With a typical gain bandwidth of 100kHz, the MIC2203 is capable of extremely fast transient responses.

The MIC2203 is designed to be stable with a 10 μ H inductor and a 2.2 μ F ceramic (X5R) output capacitor.

Feedback

The MIC2203 provides a feedback pin to adjust the output voltage to the desired level. This pin connects internally to an error amplifier. The error amplifier then compares the voltage at the feedback to the internal 0.5V reference voltage and adjusts the output voltage to maintain regulation. To calculate the resistor divider network for the desired output is as follows:

$$R2 = \frac{R1}{\left(\frac{V_{OUT}}{V_{REF}} - 1 \right)}$$

Where V_{REF} is 0.5V and V_{OUT} is the desired output voltage. A 10k Ω or lower resistor value from the output to the feedback is recommended. Larger resistor values require an additional capacitor (feed-forward) from the output to the feedback. The large high side resistor value and the parasitic capacitance on the feedback pin (~10pF) can cause an additional pole in the loop. The additional pole

can create a phase loss at high frequency. This phase loss degrades transient response by reducing phase margin. Adding feed-forward capacitance negates the parasitic capacitive effects of the feedback pin.

Also, large feedback resistor values increase the impedance, making the feedback node more susceptible to noise pick-up. A feed-forward capacitor would also reduce noise pick-up by providing a low impedance path to the output.

PWM Operation

The MIC2203 is a pulse width modulation (PWM) regulator. By controlling the ratio of on-to-off time, or duty cycle, a regulated DC output voltage is achieved. As load or supply voltage changes, so does the duty cycle to maintain a constant output voltage. In cases where the input supply runs into a dropout condition, the MIC2203 will run at 100% duty cycle.

The MIC2203 provides constant switching at 1MHz with synchronous internal MOSFETs. The internal MOSFETs include a high-side P-Channel MOSFET from the input supply to the switch pin and an N-Channel MOSFET from the switch pin-to-ground. Since the low-side N-Channel MOSFET provides the current during the off cycle, a free wheeling Schottky diode from the switch node to ground is not required.

PWM control provides fixed frequency operation. By maintaining a constant switching frequency, predictable fundamental and harmonic frequencies are achieved. Other methods of regulation, such as burst and skip modes, have frequency spectrums that change with load that can interfere with sensitive communication equipment.

Synchronization

SYNC_IN allows the user to change the frequency from 1MHz up to 1.25MHz or down to 800kHz. This allows the ability to control the fundamental frequency and all the resultant harmonics.

Maintaining a predictable frequency creates the ability to either shift the harmonics away from sensitive carrier and IF frequency bands or to accurately filter out specific harmonic frequencies.

The SYNC_OUT function pin allows for the ability to be able to sync up multiple MIC2203s in a "daisy-chain", connecting SYNC_OUT to SYNC_IN of the other MIC2203. Synchronizing multiple MIC2203s benefits much in the same way as syncing up one MIC2203. All regulators will run at the same fundamental frequency, resulting in matched harmonic frequencies, simplifying design for sensitive communication equipment.

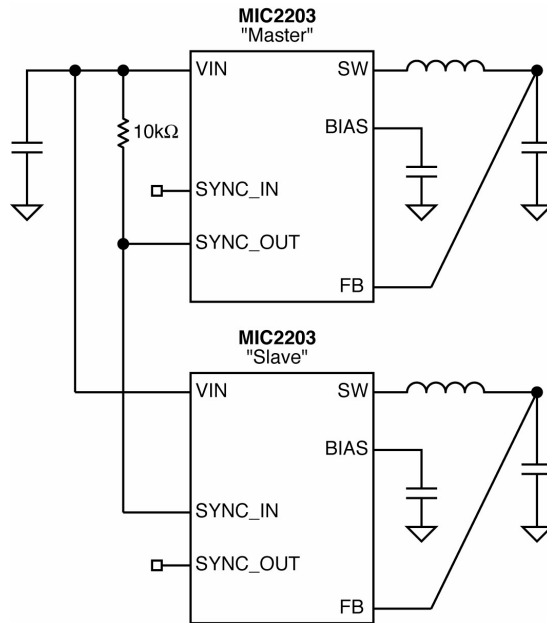
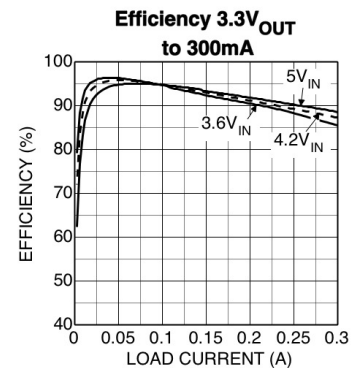
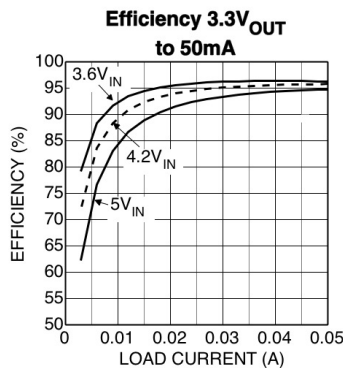
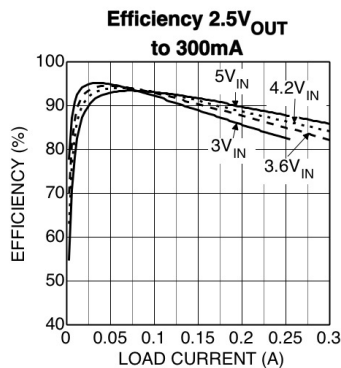
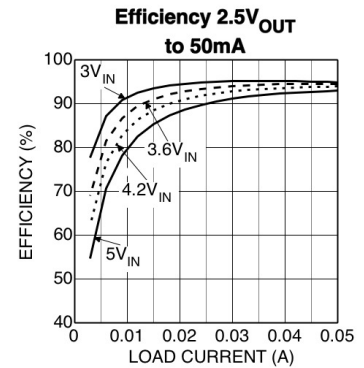
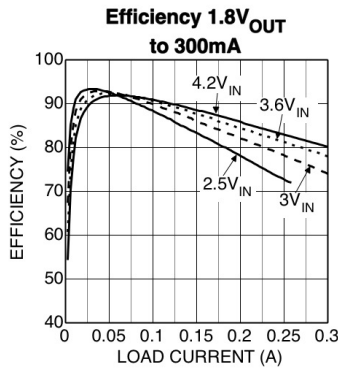
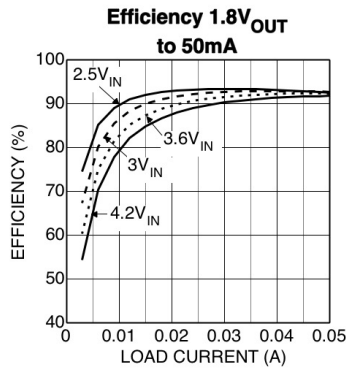
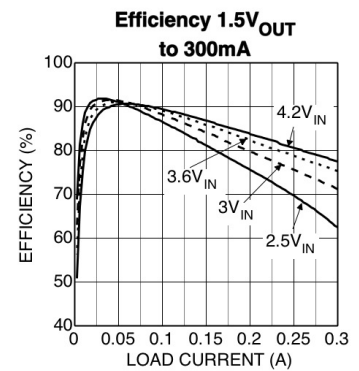
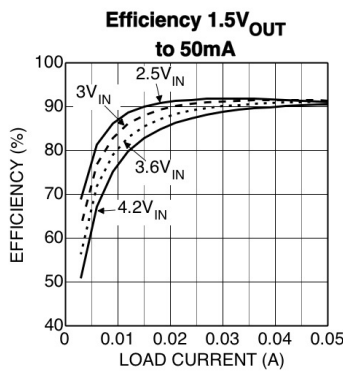
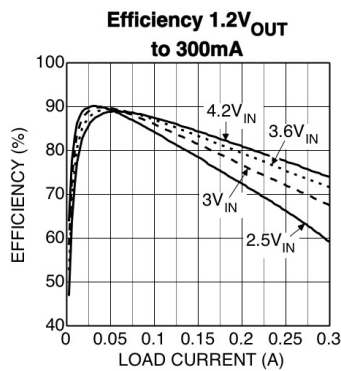
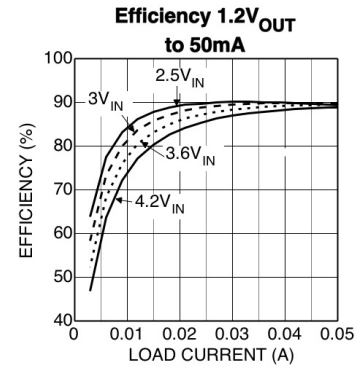
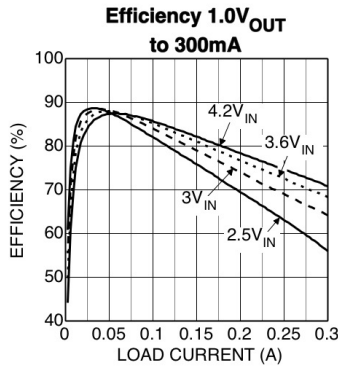
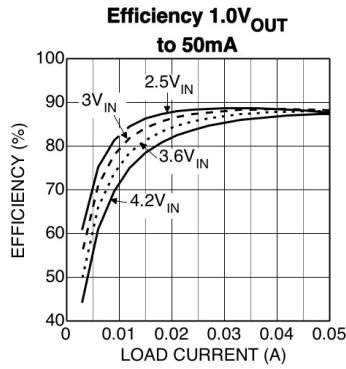
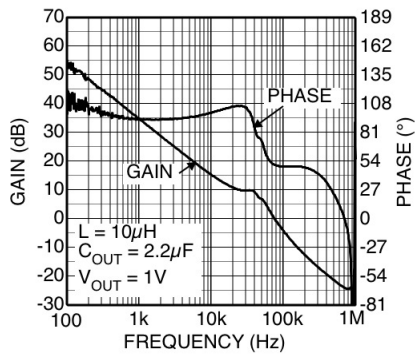

Figure 1. Master-Slave Operation

MIC2203 with 10 μ H Inductor and 2.2 μ F Output Capacitor



MIC2203 Gain Phase Plot



Line Transient

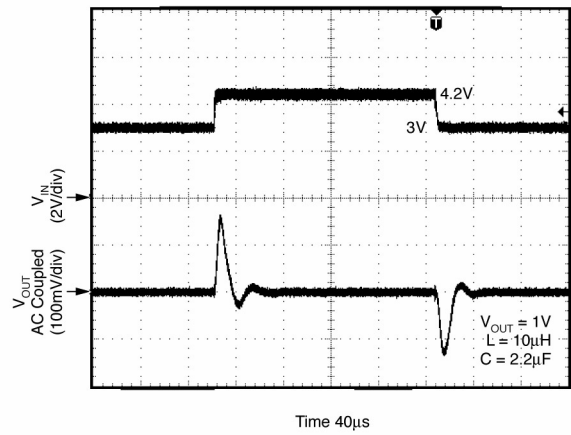

Load Transient

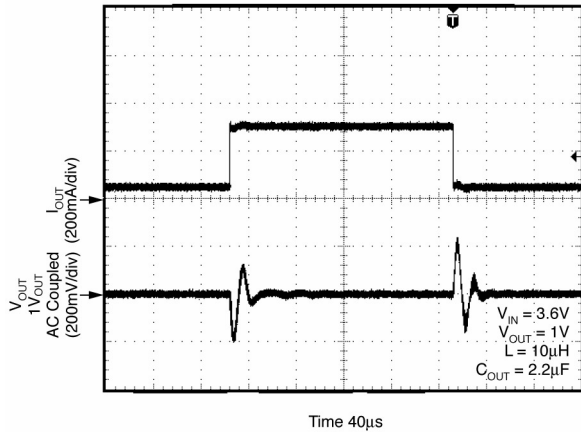

Ripple

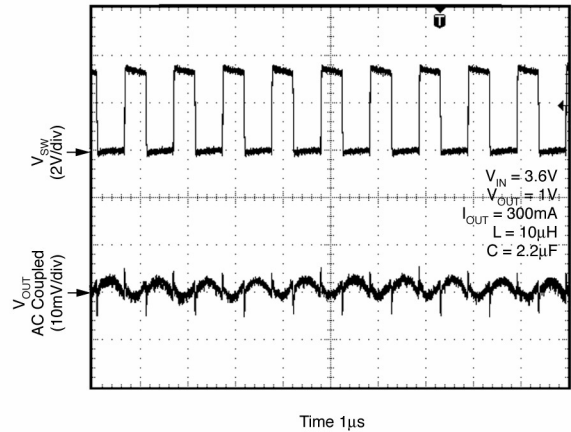

Turn-On Transient

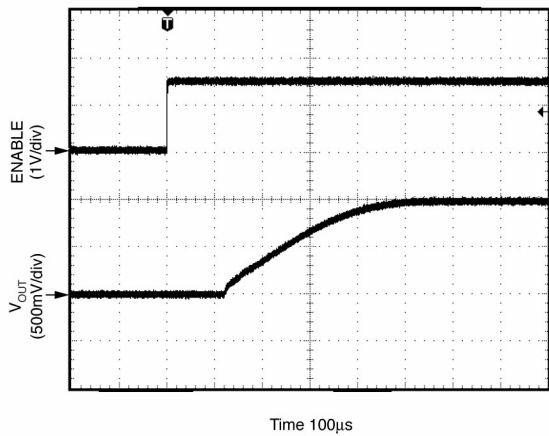

Turn-Off Transient

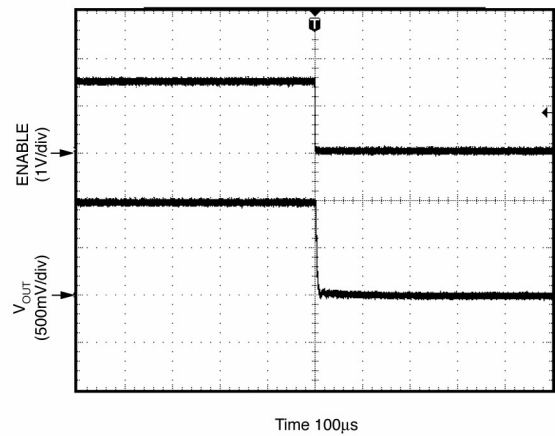

MIC2203BMM Evaluation Board Schematic

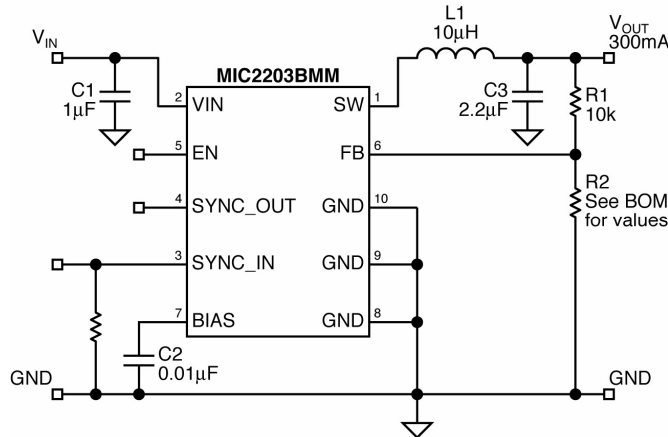

Figure 2. MIC2203BMM Evaluation Board Schematic

Bill of Materials

Item	Part Number	Manufacturer	Description
C1	06036D105MAT	AVX	1µF Ceramic Capacitor X5R, 6.3V, Size 0603
	GRM185R60J105KE21D	Murata	1µF Ceramic Capacitor X5R, 6.3V, Size 0603
C2	0201ZD103MAT2	AVX	10nF Ceramic Capacitor 6.3V, Size 0201
	GRM033R10J103KA01D	Murata	10nF Ceramic Capacitor 6.3V, Size 0202
C3	06036D225MAT	AVX	2.2µF Ceramic Capacitor X5R, 6.3V, Size 0603
	GRM185R60J22SKE21D	Murata	2.2µF Ceramic Capacitor X5R, 6.3V, Size 0603
L1	LQH32CN100M	Murata	10µH Inductor
	CDRH2D14-10	Sumida	10µH Inductor
R1	CRCW04021002F	Vishay-Dale	10kΩ 1%, Size 0402
R2	CRCW04021781F	Vishay-Dale	1.78kΩ 1%, Size 0402 For 3.3V _{OUT}
	CRCW04022491F	Vishay-Dale	2.49kΩ 1%, Size 0402 For 2.5V _{OUT}
	CRCW04023831F	Vishay-Dale	3.83kΩ 1%, Size 0402 For 1.8V _{OUT}
	CRCW04024991F	Vishay-Dale	4.99kΩ 1%, Size 0402 For 1.5V _{OUT}
	CRCW04027151F	Vishay-Dale	7.15kΩ 1%, Size 0402 For 1.2V _{OUT}
	CRCW04021002F	Vishay-Dale	10kΩ 1%, Size 0402 For 1V _{OUT}
	NA		Open For 0.5V _{OUT}
U1	MIC2203BMM	Micrel, Inc.	1MHz High Efficiency Synchronous Buck Regulator

Notes:

1. AVX: www.avx.com
2. Murata: www.murata.com
3. Sumida: www.sumida.com
4. Vishay-Dale: www.vishay.com
5. **Micrel, Inc:** www.micrel.com

